

Tipo / Type
3F

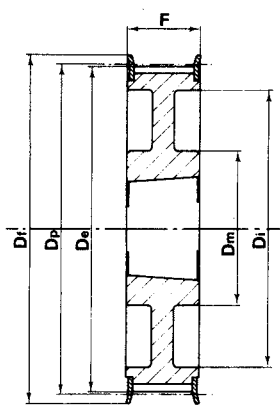

Tipo / Type
3WF

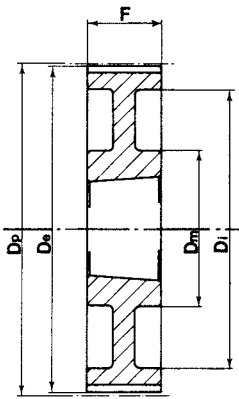

Tipo / Type
3W

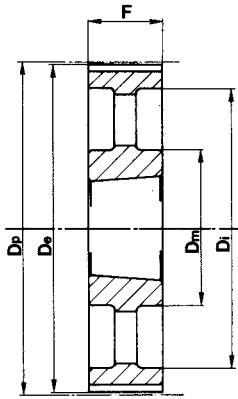

Tipo / Type
3A

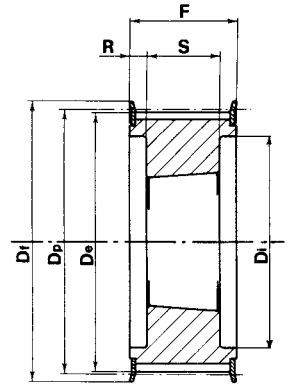

Tipo / Type
4F

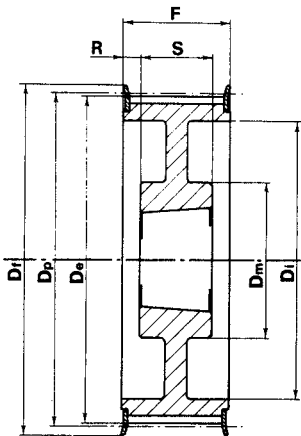

Tipo / Type
4WF

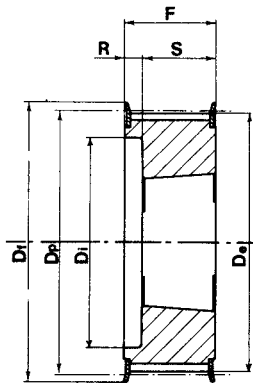

Tipo / Type
5F

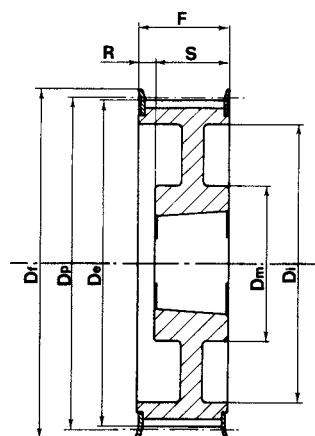

Tipo / Type
5WF

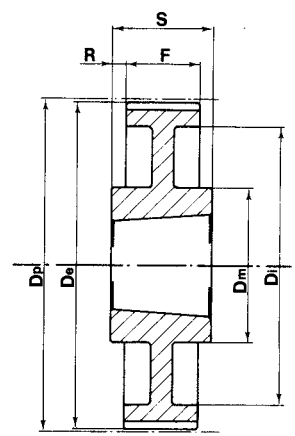

Tipo / Type
7W

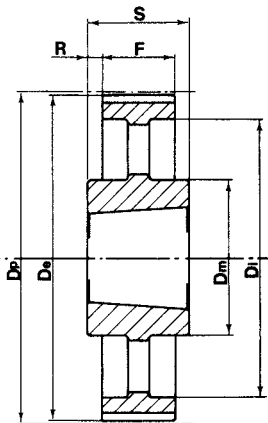

Tipo / Type
7A

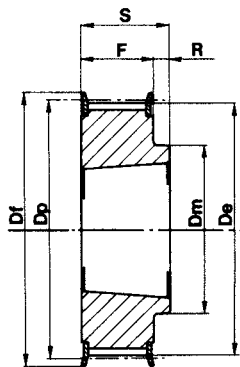

Tipo / Type
8F

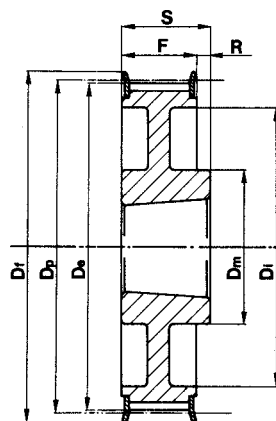

Tipo / Type
8WF

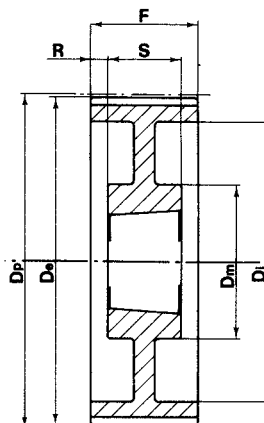

Tipo / Type
9W

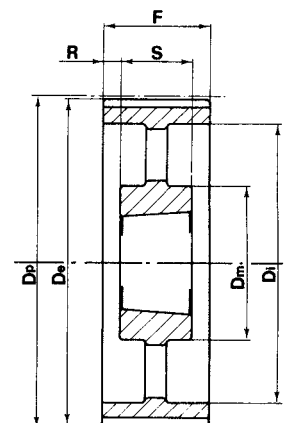

Tipo / Type
9A

Pulegge dentate per bussola conica / Timing belt pulleys for taper bushes
Zahnriemenscheiben für Spannbüchsen / Poulies dentées à moyeu amovible
Poleas dentadas para casquillos cónicos (taper)



L 050 - 3/8" (9,525 mm)

Caratteristiche Features Merkmale Características	Codice Code symbol Fabriknummer Code symbole Numero de fabrica	Nostro codice Our code Unser kode Notre code Nuestro codigo	Tipo Type Typ Type Tipo	Codice flangia Flange code Bordscheiben-Code Code flasque Código brida	Bussola Bush Buchse Moyeu Casquillo	Foro max. Max. Bore Max. Bohrung Alesage max. Agujero max.	Dp	De	Df	Dm	Di	F	S	R	Peso Weight / Gewicht Poids / Peso Kg	
Acciaio / Steel / Stahl Acier / Acero	con flangia / with flanges mit Flanges / avec flasques / con tapetas	18L050	TL50018	8F	FL058	1108	28	54,57	53,81	60,0	45	-	19,0	22,0	3,0	0,2
		19L050	TL50019	8F	FL059	1108	28	57,61	56,84	64,0	45	-	19,0	22,0	3,0	0,2
		20L050	TL50020	8F	FL060	1108	28	60,64	59,88	66,5	48	-	19,0	22,0	3,0	0,2
		21L050	TL50021	8F	FL061	1108	28	63,67	62,91	70,0	48	-	19,0	22,0	3,0	0,3
		22L050	TL50022	8F	FL062	1108	28	66,70	65,94	75,0	51	-	19,0	22,0	3,0	0,3
		23L050	TL50023	8F	FL063	1108	28	69,73	68,97	79,0	54	-	19,0	22,0	3,0	0,4
		24L050	TL50024	8F	FL063	1108	28	72,77	72,00	79,0	54	-	19,0	22,0	3,0	0,4
		25L050	TL50025	8F	FL064	1108	28	75,80	75,04	82,5	56	-	19,0	22,0	3,0	0,5
		26L050	TL50026	8F	FL065	1108	28	78,83	78,07	86,0	60	-	19,0	22,0	3,0	0,5
		27L050	TL50027	8F	FL065	1108	28	81,86	81,10	86,0	62	-	19,0	22,0	3,0	0,6
		28L050	TL50028	8F	FL066	1108	28	84,89	84,13	91,0	65	-	19,0	22,0	3,0	0,6
		30L050	TL50030	8F	FL068	1108	28	90,96	90,20	97,0	70	-	19,0	22,0	3,0	0,8
		32L050	TL50032	8F	FL070	1108	28	97,02	96,26	102,0	74	-	19,0	22,0	3,0	0,9
		36L050	TL50036	8F	FL074	1108	28	109,15	108,39	115,0	85	-	19,0	22,0	3,0	1,2
		40L050	TL50040	8F	FL078	1610	42	121,28	120,51	128,0	88	-	19,0	25,0	6,0	1,5
		44L050	TL50044	8WF	FL081	1610	42	133,40	132,64	142,0	88	110	19,0	25,0	6,0	1,8
48L050	TL50048	8WF	FL085	1610	42	145,53	144,77	150,0	88	120	19,0	25,0	6,0	2,3		
Ghisa / Cast iron Grauguss / Fonte Hierro fundido	senza flangia / without flanges ohne Flanschen sans flasques / sin tapetas	60L050	TL50060	7W	-	1610	42	181,91	181,15	-	92	166	19,0	25,0	3,0	2,0
		72L050	TL50072	7A	-	1610	42	218,30	217,53	-	92	202	19,0	25,0	3,0	3,0
		84L050	TL50084	7A	-	1610	42	254,68	253,90	-	92	236	19,0	25,0	3,0	4,0
		96L050	TL50096	7A	-	2012	50	291,06	290,30	-	106	270	19,0	32,0	6,5	5,5
		120L050	TL50120	7A	-	2012	50	363,83	363,07	-	106	343	19,0	32,0	6,5	6,8

Pulegge dentate per bussola conica / Timing belt pulleys for taper bushes
Zahnriemenscheiben für Spannbüchsen / Poulies dentées à moyeu amovible
Poleas dentadas para casquillos cónicos (taper)

L 075 - 3/8" (9,525 mm)

Caratteristiche Features Merkmale Características	Codice Code symbol Fabriknummer Code symbole Numero de fabrica	Nostro codice Our code Unser kode Notre code Nuestro codiglo	Tipo Type Typ Type Tipo	Codice flangia Flange code Bordscheiben-Code Code flasque Código brida	Bussola Bush Buchse Moyeu Casquillo	Foro max. Max. Bore Max. Bohrung Alesage max. Agujero max.	Dp	De	Df	Dm	Di	F	S	R	Peso Weight / Gewicht Poids / Peso Kg	
Acciaio / Steel / Stahl Acier / Acero	con flangia / with flanges mit Flanges / avec flasques / con tapetas	18L075	TL75018	3F	FL058	1108	28	54,57	53,81	60,0	-	-	25,0	25,0	-	0,2
		19L075	TL75019	3F	FL059	1108	28	57,61	56,84	64,0	-	-	25,0	25,0	-	0,3
		20L075	TL75020	3F	FL060	1108	28	60,64	59,88	66,5	-	-	25,0	25,0	-	0,3
		21L075	TL75021	3F	FL061	1108	28	63,67	62,91	70,0	-	-	25,0	25,0	-	0,4
		22L075	TL75022	3F	FL062	1108	28	66,70	65,94	75,0	-	-	25,0	25,0	-	0,4
		23L075	TL75023	3F	FL063	1108	28	69,73	68,97	79,0	-	-	25,0	25,0	-	0,4
		24L075	TL75024	3F	FL063	1108	28	72,77	72,00	79,0	-	-	25,0	25,0	-	0,5
		25L075	TL75025	3F	FL064	1108	28	75,80	75,04	82,5	-	-	25,0	25,0	-	0,6
		26L075	TL75026	3F	FL065	1108	28	78,83	78,07	86,0	-	-	25,0	25,0	-	0,6
		27L075	TL75027	3F	FL065	1108	28	81,86	81,10	86,0	-	-	25,0	25,0	-	0,7
		28L075	TL75028	3F	FL066	1108	28	84,89	84,13	91,0	-	-	25,0	25,0	-	0,7
		30L075	TL75030	3F	FL068	1108	28	90,96	90,20	97,0	-	-	25,0	25,0	-	0,9
		32L075	TL75032	3F	FL070	1108	28	97,02	96,26	102,0	-	-	25,0	25,0	-	1,0
		36L075	TL75036	3F	FL074	1610	42	109,15	108,39	115,0	-	-	25,0	25,0	-	1,2
		40L075	TL75040	3F	FL078	1610	42	121,28	120,51	128,0	-	-	25,0	25,0	-	1,7
Ghisa / Cast iron Grauguss / Fonte Hierro fundido	senza flangia without flanges ohne Flanschen sans flasques sin tapetas	44L075	TL75044	3WF	FL081	1610	42	133,40	132,64	142,0	90	110	25,0	25,0	-	2,1
		48L075	TL75048	3WF	FL085	1610	42	145,53	144,77	150,0	92	120	25,0	25,0	-	2,5
		60L075	TL75060	3W	-	1610	42	181,91	181,15	-	92	166	25,0	25,0	-	3,0
		72L075	TL75072	3A	-	1610	42	218,30	217,53	-	92	202	25,0	25,0	-	4,0
		84L075	TL75084	7A	-	2012	50	254,68	253,90	-	92	236	25,0	32,0	3,5	5,2
		96L075	TL75096	7A	-	2012	50	291,06	290,30	-	106	270	25,0	32,0	3,5	6,5
		120L075	TL75120	7A	-	2012	50	363,83	363,07	-	106	343	25,0	32,0	3,5	7,6

L 100 - 3/8" (9,525 mm)

Caratteristiche Features Merkmale Características	Codice Code symbol Fabriknummer Code symbole Numero de fabrica	Nostro codice Our code Unser kode Notre code Nuestro codiglo	Tipo Type Typ Type Tipo	Codice flangia Flange code Bordscheiben-Code Code flasque Código brida	Bussola Bush Buchse Moyeu Casquillo	Foro max. Max. Bore Max. Bohrung Alesage max. Agujero max.	Dp	De	Df	Dm	Di	F	S	R	Peso Weight / Gewicht Poids / Peso Kg	
Acciaio / Steel / Stahl Acier / Acero	con flangia / with flanges mit Flanges / avec flasques / con tapetas	18L100	TL10018	5F	FL058	1108	28	54,57	53,81	60,0	-	38	31,0	22,0	9,0	0,2
		19L100	TL10019	5F	FL059	1108	28	57,61	56,84	64,0	-	38	31,0	22,0	9,0	0,3
		20L100	TL10020	5F	FL060	1108	28	60,64	59,88	66,5	-	45	31,0	22,0	9,0	0,4
		21L100	TL10021	5F	FL061	1108	28	63,67	62,91	70,0	-	45	31,0	22,0	9,0	0,4
		22L100	TL10022	5F	FL062	1108	28	66,70	65,94	75,0	-	48	31,0	22,0	9,0	0,4
		23L100	TL10023	5F	FL063	1108	28	69,73	68,97	79,0	-	52	32,0	22,0	10,0	0,5
		24L100	TL10024	5F	FL063	1108	28	72,77	72,00	79,0	-	52	32,0	22,0	10,0	0,6
		25L100	TL10025	5F	FL064	1108	28	75,80	75,04	82,5	-	54	32,0	22,0	10,0	0,6
		26L100	TL10026	5F	FL065	1108	28	78,83	78,07	86,0	-	60	32,0	22,0	10,0	0,7
		27L100	TL10027	5F	FL065	1108	28	81,86	81,10	86,0	-	60	32,0	22,0	10,0	0,8
		28L100	TL10028	5F	FL066	1108	28	84,89	84,13	91,0	-	65	32,0	22,0	10,0	0,8
		30L100	TL10030	5F	FL068	1210	32	90,96	90,20	97,0	-	71	32,0	25,0	7,0	0,9
		32L100	TL10032	5F	FL070	1210	32	97,02	96,26	102,0	-	75	32,0	25,0	7,0	1,0
		36L100	TL10036	5F	FL074	1610	42	109,15	108,39	115,0	-	86	32,0	25,0	7,0	1,4
		40L100	TL10040	5F	FL078	1610	42	121,28	120,51	128,0	-	96	32,0	25,0	7,0	1,7
Ghisa / Cast iron Grauguss / Fonte Hierro fundido	senza flangia without flanges ohne Flanschen sans flasques sin tapetas	44L100	TL10044	5WF	FL081	1610	42	133,40	132,64	142,0	90	110	32,0	25,0	7,0	2,3
		48L100	TL10048	5WF	FL085	1610	42	145,53	144,77	150,0	92	120	32,0	25,0	7,0	2,7
		60L100	TL10060	9W	-	1610	42	181,91	181,15	-	92	166	32,0	25,0	3,5	2,4
		72L100	TL10072	3A	-	2012	50	218,30	217,53	-	92	202	32,0	32,0	-	4,4
		84L100	TL10084	3A	-	2012	50	254,68	253,90	-	92	236	32,0	32,0	-	6,0
		96L100	TL10096	3A	-	2012	50	291,06	290,30	-	106	270	32,0	32,0	-	7,1
		120L100	TL10120	3A	-	2012	50	363,83	363,07	-	106	343	32,0	32,0	-	8,5